

# CANNELLA



## INFORMAZIONI TECNICHE

Struttura legno e derivati con molle greche.  
Imbottitura seduta in poliuretano.  
Imbottitura spalliera in fiocco siliconato.  
Rivestimento pelli selezionate.  
Rivestimento tessuti selezionati.  
Cuscini di seduta non amovibili.  
Non sfoderabile.  
Cuscini ornamentali non inclusi.



## DETTAGLI

Piedi in metallo h. 13,5cm



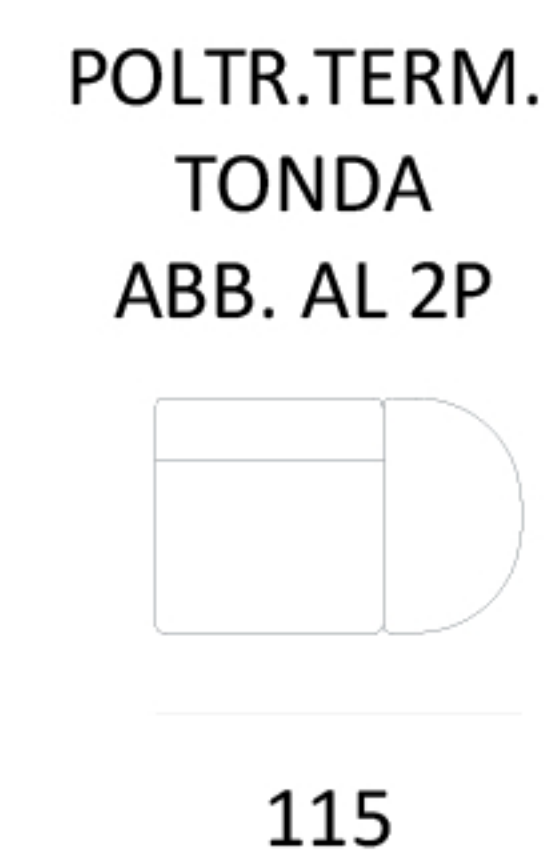
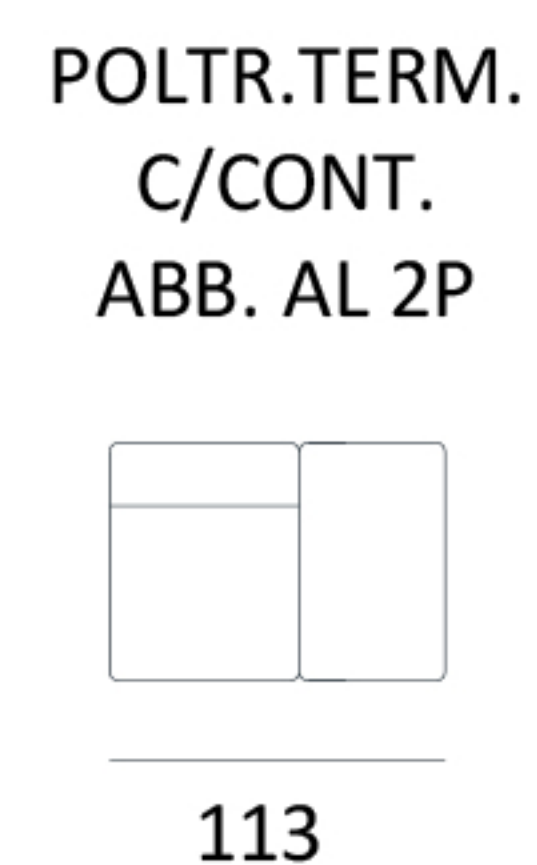
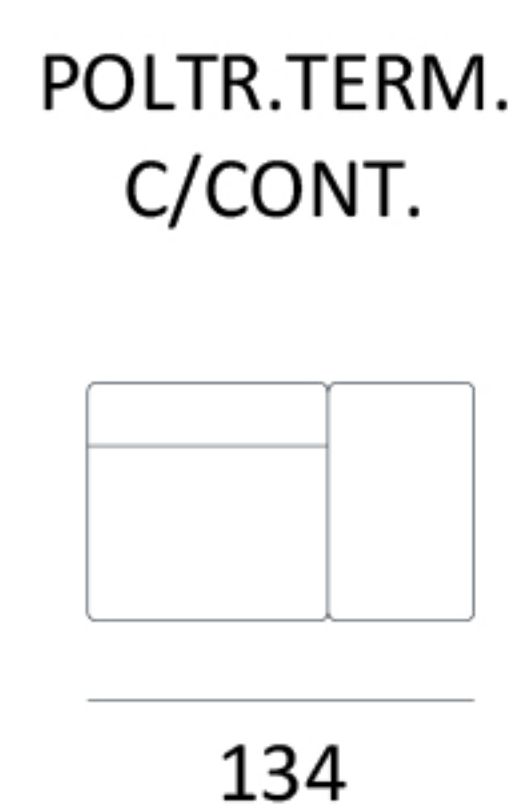
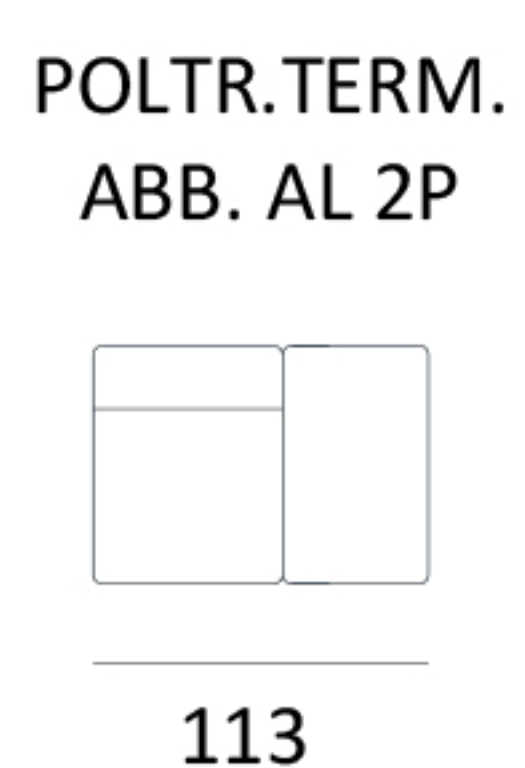
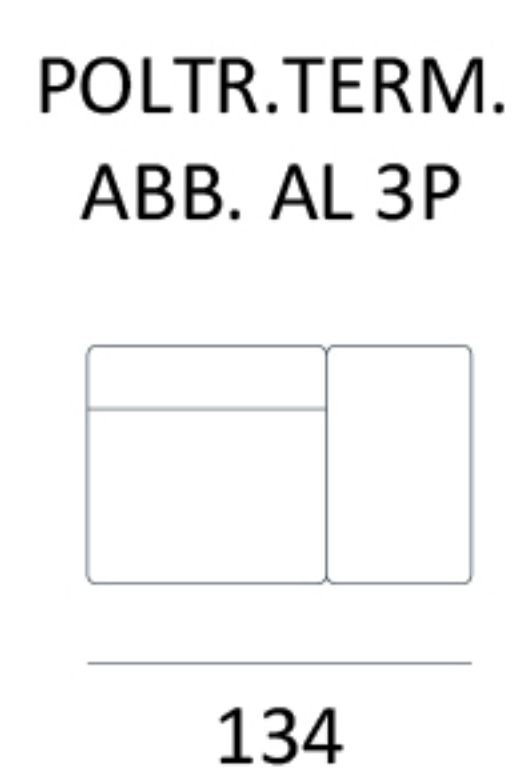
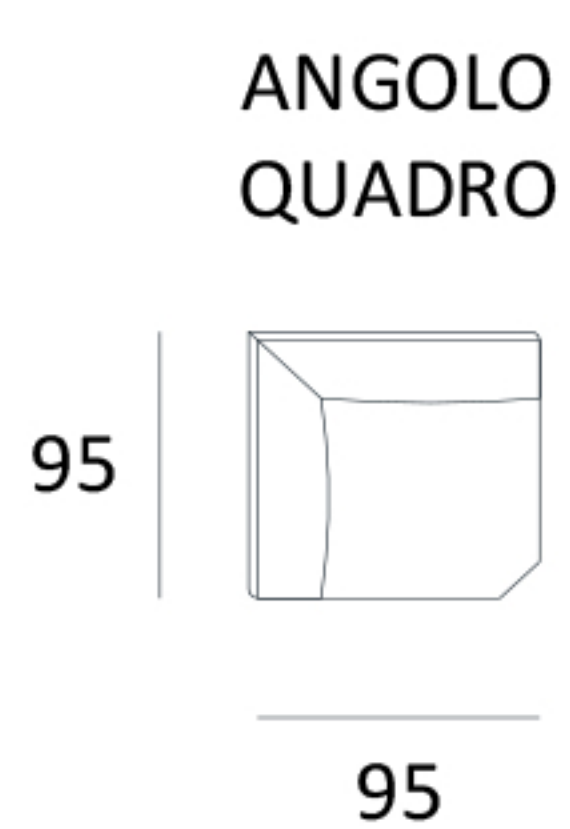
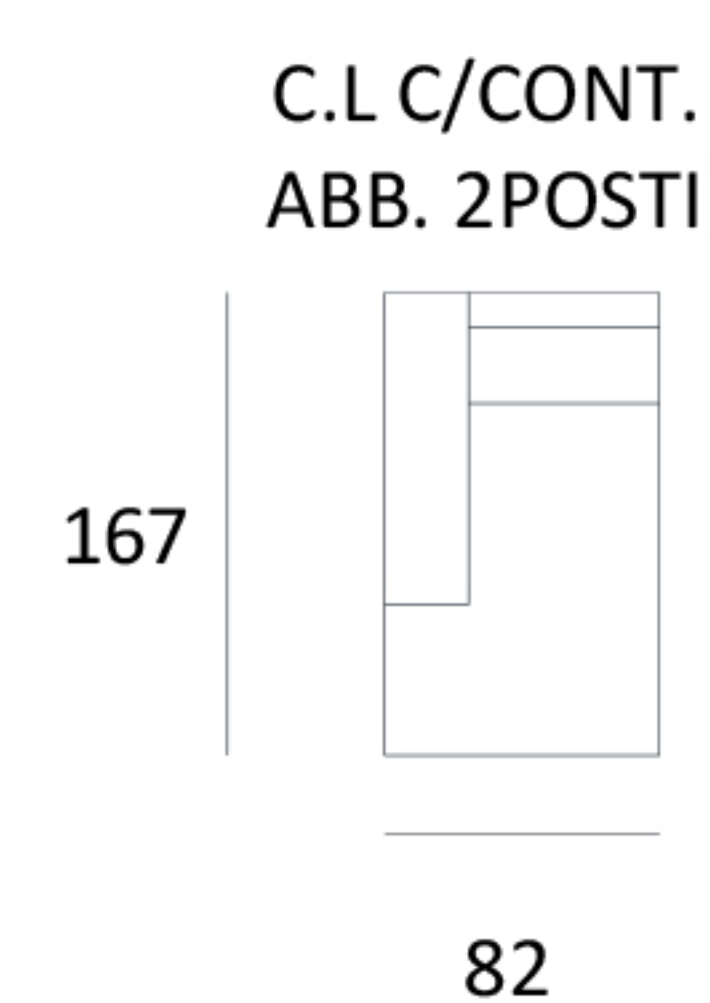
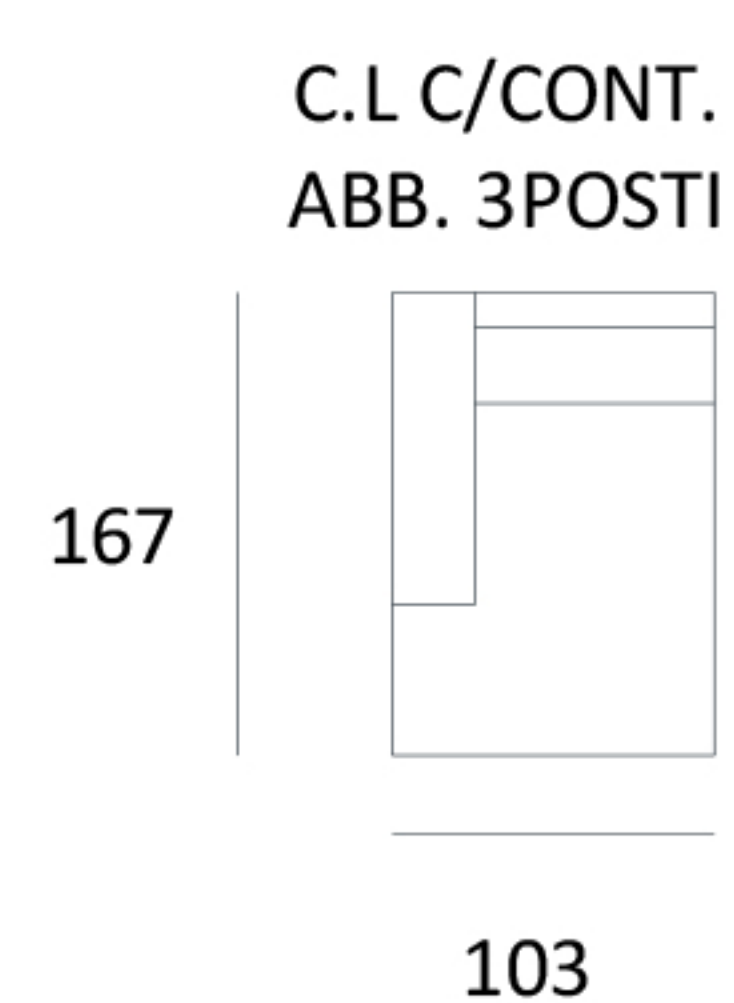
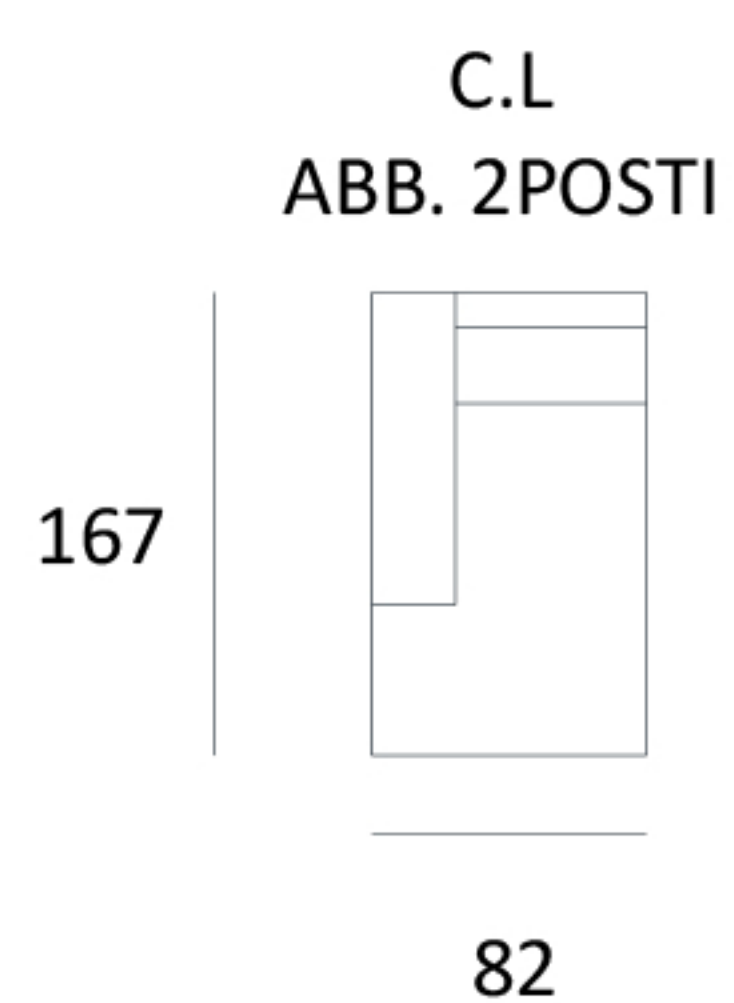
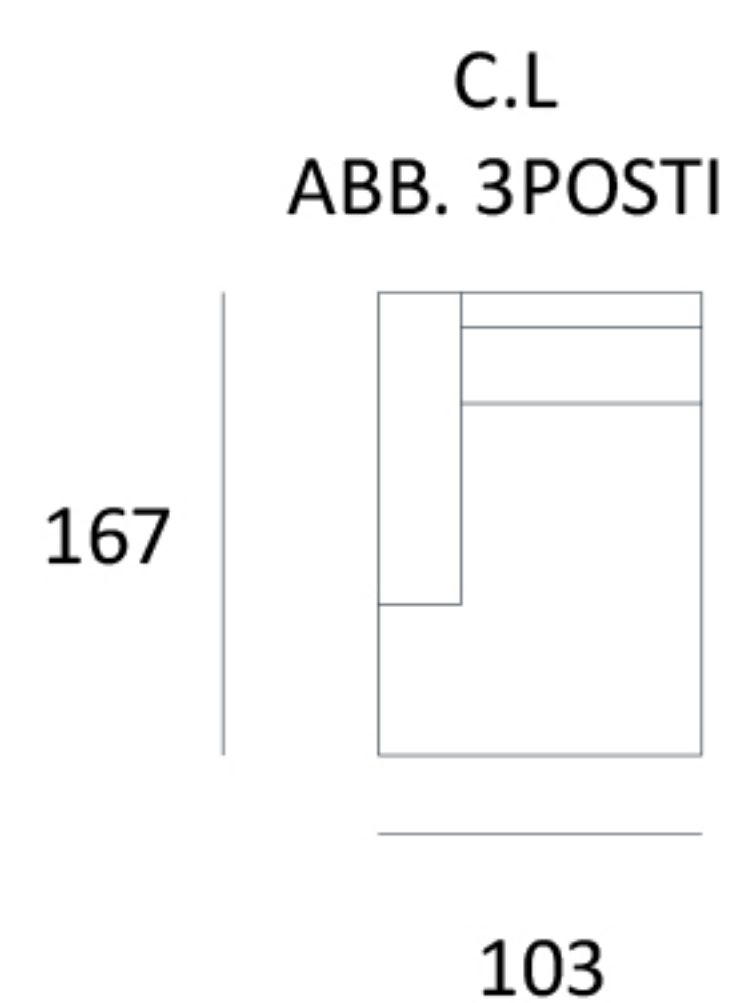
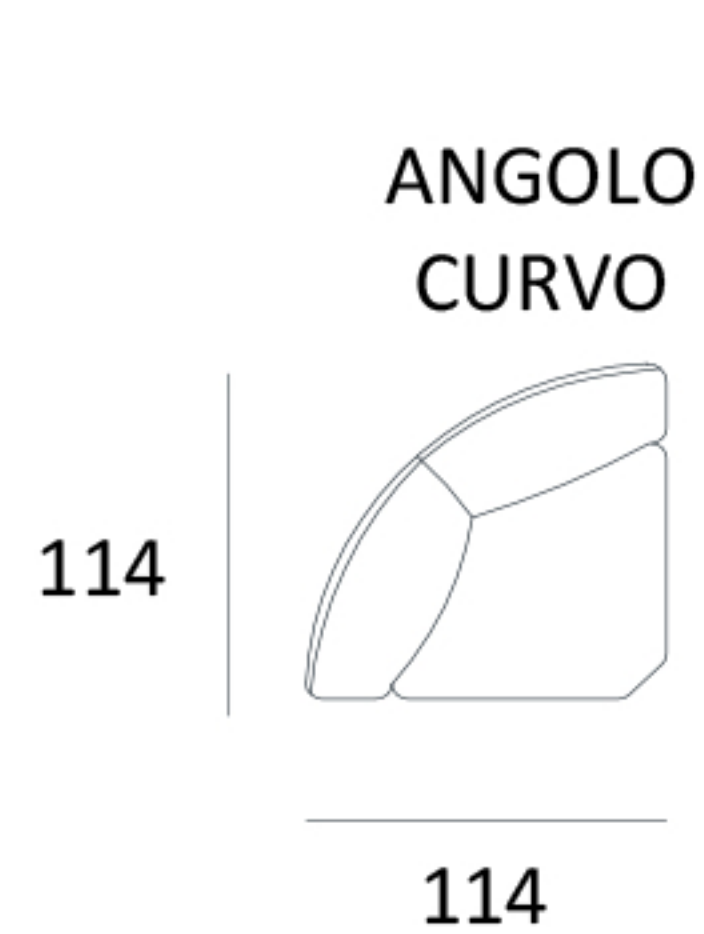
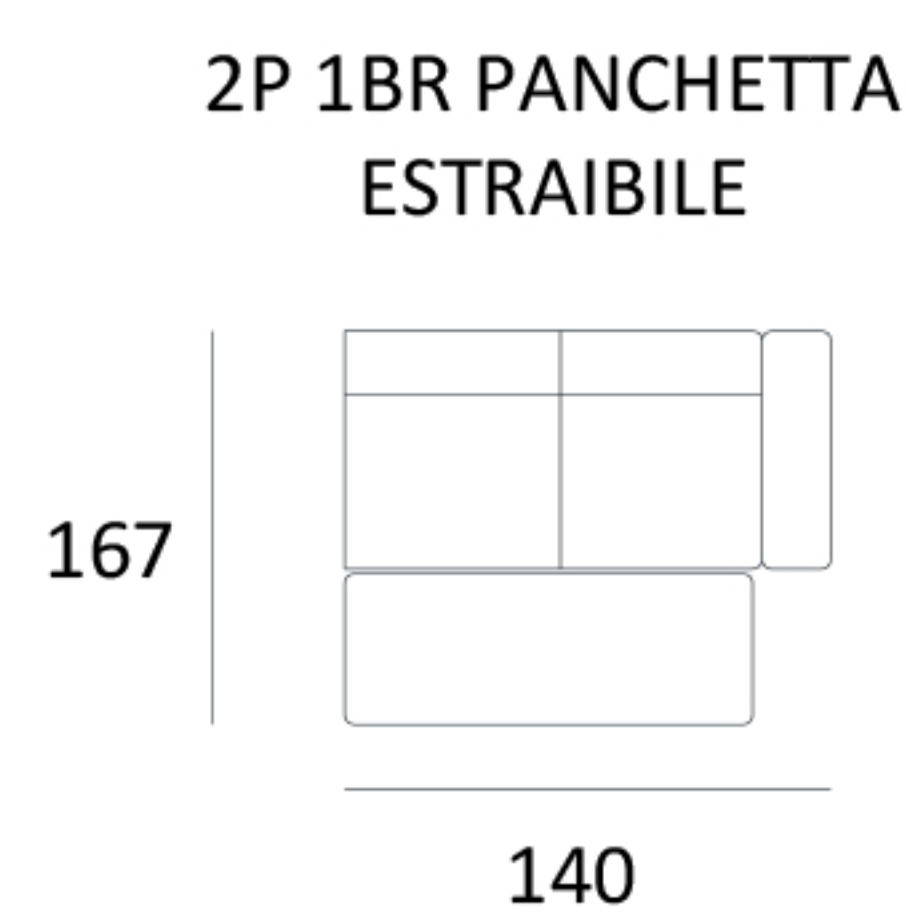
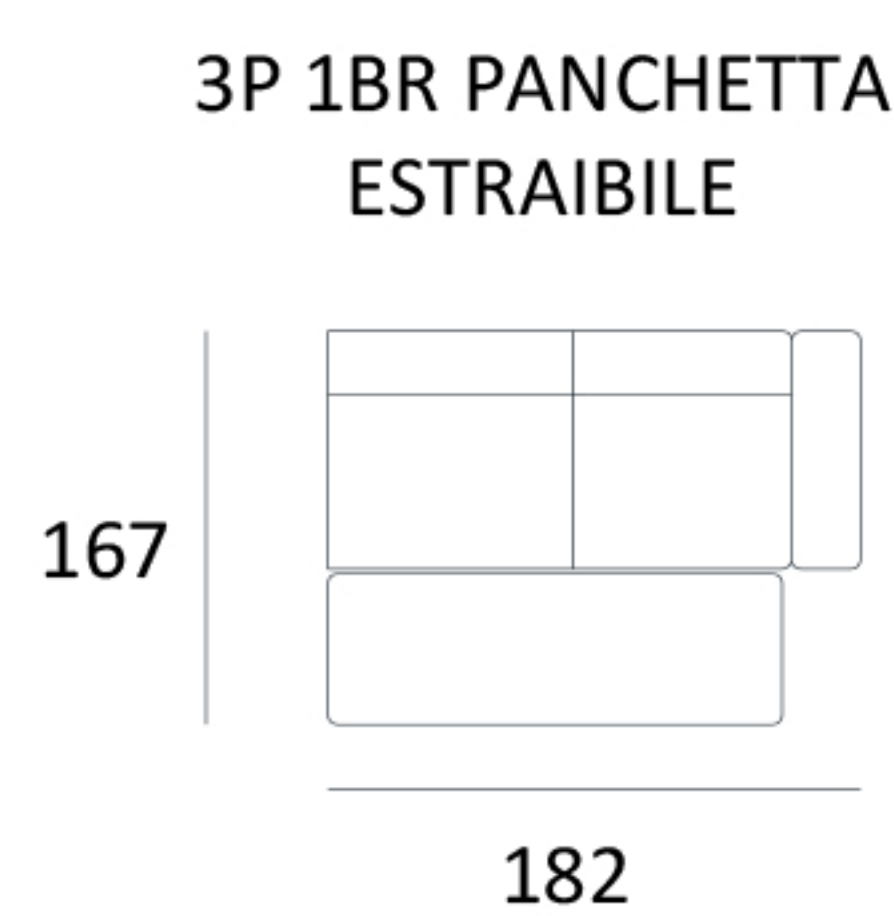
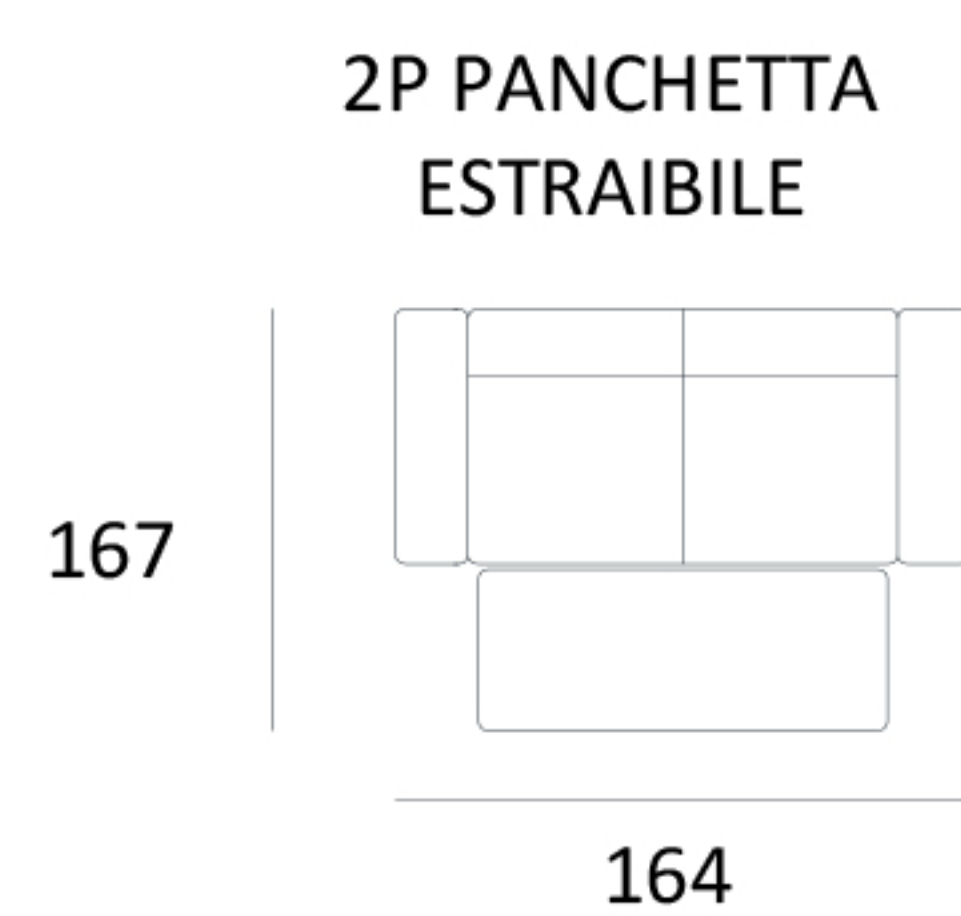
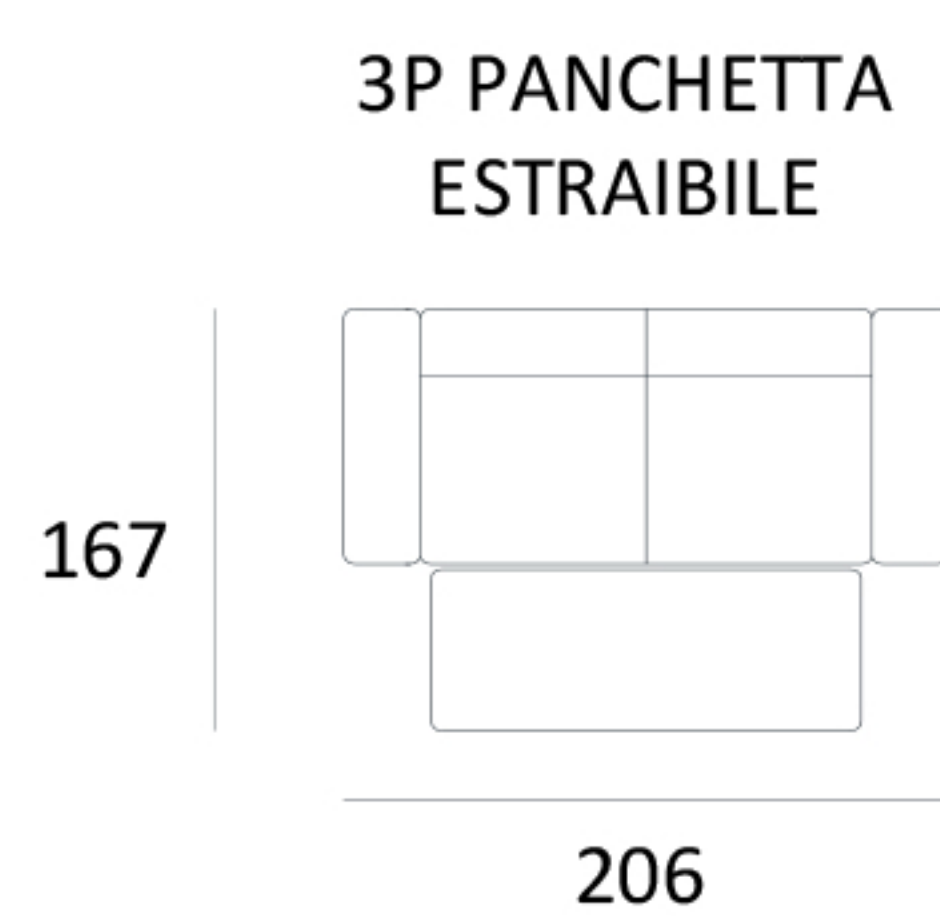
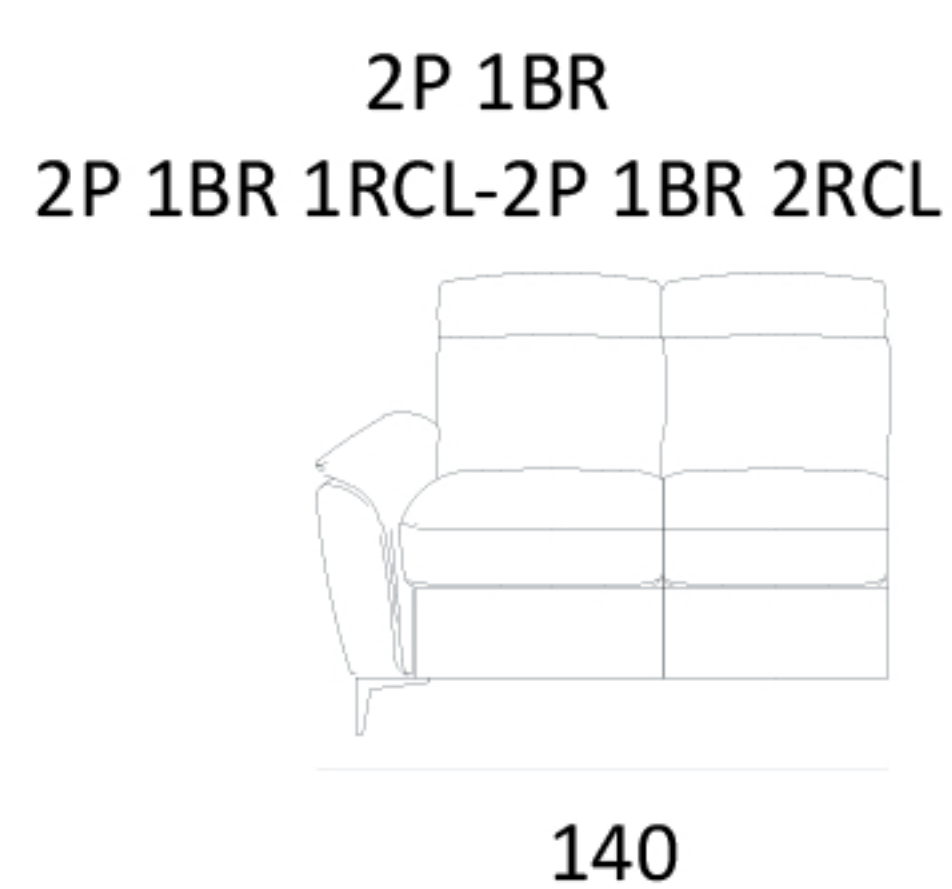
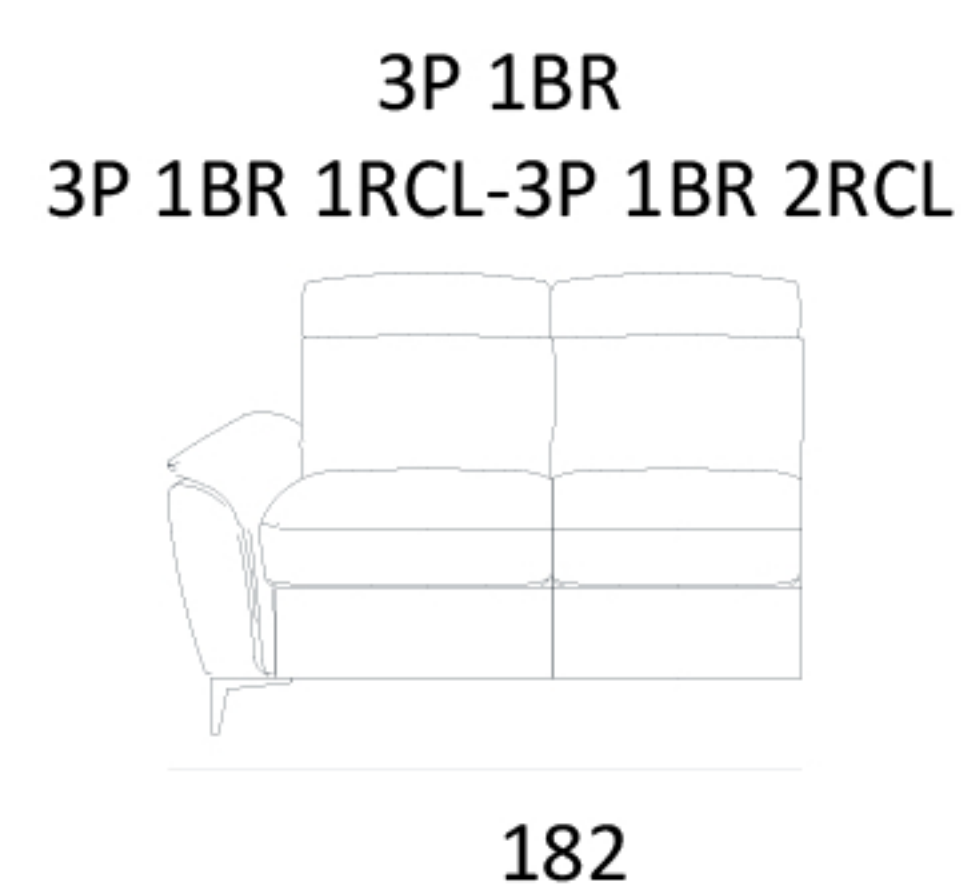
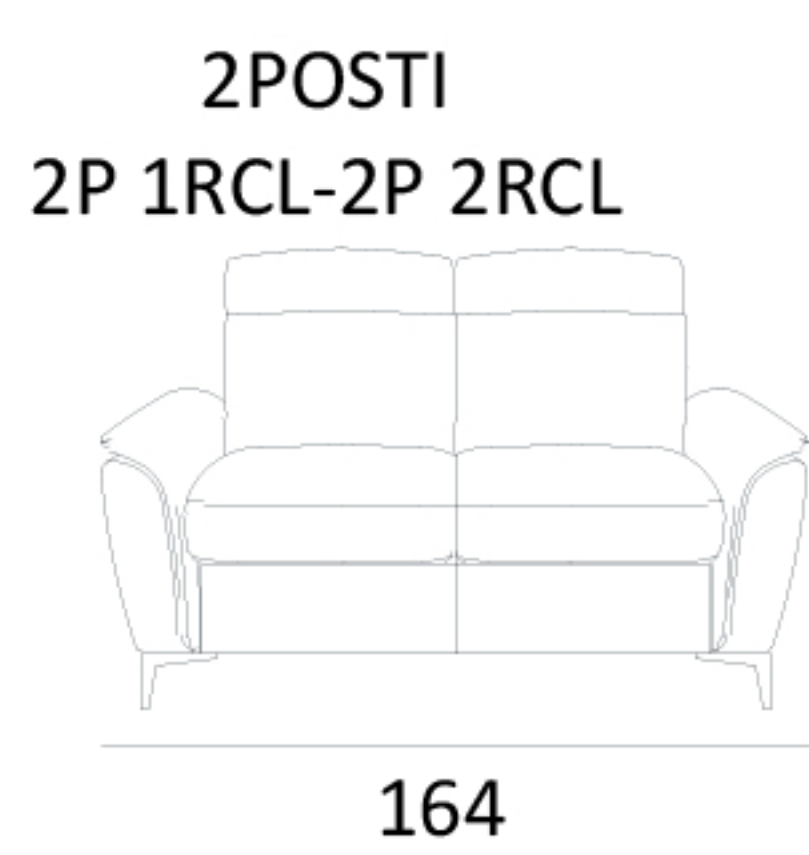

SEDUTA IN DENSITA' 30 x KG. E CON  
SOSPENSIONE A MOLLE GRECHE E  
SUPPORTO IN FODERA